

COMO IEC/UL

Load break switches
from 30 to 63 A

2021

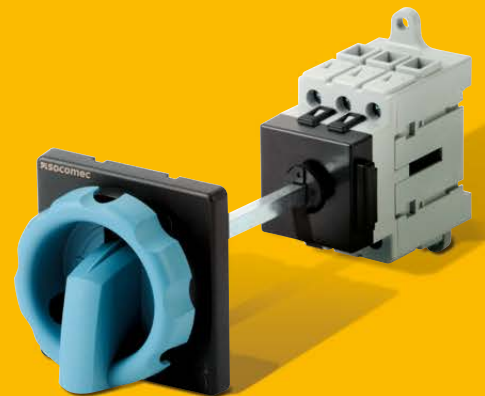

When **energy** matters

COMO

Load break switches
from 30 to 63 A

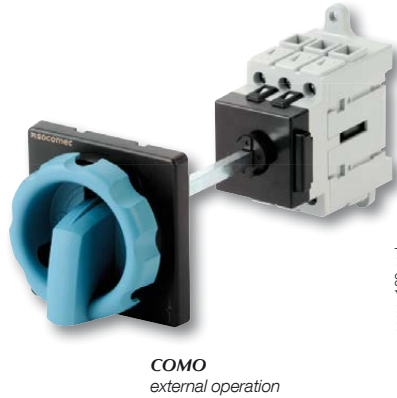

Function

COMO are compact and modular load break switches. They make and break under all types of load conditions and provide safe isolation for any low voltage circuit, especially for machine control circuits.

General characteristics

- 2 stable positions (I, 0)
- Double break per phase
- Positive contact indication
- Contact point technology
- Padlocking in 0 position
- IP20 devices and accessories

Advantages

Easy mounting

Three mounting possibilities are available for optimum integration and time saving:

- DIN rail or back plate mounting,
- Door mounting,
- "Quick Fix" mounting to save time when integrating in high quantities.

Compact

Thanks to its compact design panel space is greatly reduced.

Safety

- Direct access to connection terminals for adequate tightening
- Lockable rotary operating mechanism

The solution for

- > Industrial control systems

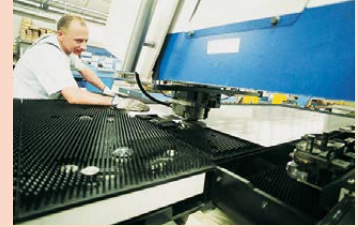

Strong points

- > Easy mounting
- > Compact
- > Safety

Conformity to standards

- > IEC 60947-3



- > UL 60947-4-1⁽¹⁾



⁽¹⁾ New UL standard replaces UL508

Local safety enclosures

- > The COMO is fitted within a polycarbonate enclosure and can be used, for example, for on load breaking of a motor (HP rated).

References

DIN rail/back plate mounting

Rating (A)		Type	Switch	4 th pole	External handle K1 type IP65 - 4/4X blue/black no defeater	External handle K1 type IP65 - 4/4X red/yellow no defeater	Extension shaft	Aux contact NO+NC	Neutral pole	Earth pole	Terminal shrouds
IEC	UL										
32 A	30 A	for direct operation	2111 3003	2111 1003	-	-	-	2113 4000	2111 1056	2111 1076	1 P (top and bottom) 2113 5001 3 P (top and bottom) 2113 5003
		for external operation	2111 3103		with guide shaft 2113 1112	with guide shaft 2113 1113	200 mm 2113 2200				
					with cross coupling 2113 1212	with cross coupling 2113 1213	320 mm 2113 2320				
63 A	50 A	for direct operation	2111 3005	2111 1005	-	-	-	2113 4000	2111 1056	2111 1076	1 P (top and bottom) 2113 5001 3 P (top and bottom) 2113 5003
		for external operation	2111 3105		with guide shaft 2113 1112	with guide shaft 2113 1113	200 mm 2113 2200				
					with cross coupling 2113 1212	with cross coupling 2113 1213	320 mm 2113 2320				

Door mounting

Rating (A)		Type	Switch	4 th pole	External handle K1 type IP65 - 4/4X blue/black no defeater	External handle K1 type IP65 red/yellow no defeater	Aux contact NO+NC	Neutral pole	Earth pole	Terminal shrouds
IEC	UL									
32 A	30 A	with screws	2111 3203	2111 1203	2113 1322	2113 1323	2113 4200	2111 1256	2111 1276	1 P (top and bottom) 2113 5001 3 P (top and bottom) 2113 5003
		quick fix	2111 3303		2113 1332	2113 1333				
63 A	50 A	with screws	2111 3205	2111 1205	2113 1322	2113 1323	2113 4200	2111 1256	2111 1276	1 P (top and bottom) 2113 5001 3 P (top and bottom) 2113 5003
		quick fix	2111 3305		2113 1332	2113 1333				

Accessories

External operation handle

DIN-rail or back plate mounting

Rating (A)		Handle type	With guide shaft or cross coupling	Handle colour	External IP ⁽¹⁾	Nema degree of protection	Reference
IEC	UL						
32 ... 63	30 ... 50	K1	guide shaft	black/blue	IP65	4, 4X	2113 1112
				red/yellow			2113 1113
			compensation	black/blue			2113 1212
				red/yellow			2113 1213

(1) IP: Degree of protection according to standard IEC 60529.



Door mounting

Rating (A)		Handle type	Door mounting type	Handle colour	External IP ⁽¹⁾	Nema degree of protection	Reference
IEC	UL						
32 ... 63	30 ... 50	K1	4 screws	black/blue	IP65	4, 4X	2113 1322
				red/yellow			2113 1323
			quick fix	black/blue			2113 1332
				red/yellow			2113 1333

(1) IP: Degree of protection according to standard IEC 60529.



Shaft for external handle

Use

Shaft extensions are for external front operation. The shaft is clipped directly into the COMO without using a screw.

Shafts

7.9 in (200 mm), 12.6 in (320 mm), (custom length, for high qty).

Rating (A)		Handle type	Length		Reference
IEC	UL		(in)	(mm)	
32 ... 63	30 ... 50	K1	7.9	200	2113 2200
			12.6	320	2113 2320



Additional pole

Use

Installation of this switched pole converts a 3 pole COMO into a 4 pole load break switches, 3 pole + neutral or 3 pole + earth.

The 4th pole can be mounted without tools on the right or left side of the device.

Max 2 additional modules, 1 switching module and 1 unswitched module.

Switched fourth pole module

Rating (A)		Type of mounting	Type	Reference
IEC	UL			
32	30	back mounting	switched	2111 1003
		door mounting		2111 1203
63	50	back mounting		2111 1005
		door mounting		2111 1205



Solid neutral pole

Rating (A)		Type of mounting	Type	Reference
IEC	UL			
32 ... 63	30 ... 50	back mounting	unswitched	2111 1056
		door mounting		2111 1256



Ground module

Rating (A)		Type of mounting	Type	Reference
IEC	UL			
32 ... 63	30 ... 50	back mounting	unswitched	2111 1076
		door mounting		2111 1276

Auxiliary contacts

Use

There are two types of auxiliary contact, one for back plate mounting and one for door mounting. NO+NC auxiliary contacts per device (1 on each side of the device).

Rating (A)		Type of mounting	Contact(s)	Contact type	Reference
IEC	UL				
32 ... 63	30 ... 50	back mounting	1 contact	NO+NC	2113 4000
		door mounting			2113 4200



Terminal shrouds

Use

Top and bottom protection against direct contact with terminal or connection parts.

Available in 1 or 3 pole version. Top and bottom pair.

Rating (A)		Type of mounting	No. of poles	Position	Pack (unit)	Reference
IEC	UL					
32 ... 63	30 ... 50	back/door mounting	1 P	top and bottom	2	2113 5001
			3 P			2113 5003



Characteristics

Characteristics according to IEC 60947-3

Rated current I _n	32 A	63 A
Thermal current at 40°C (A)	32	63
Thermal current at 50°C (A)	32	63
Thermal current at 60°C (A)	26	50
Rated insulation voltage U _i (V)	690	690
Rated impulse withstand voltage U _{imp} (kV)	6	6
Operational power in AC-23A (kW)		
400 VAC without pre-break AC	11.5	22
Operational power in AC-3 (kW)		
400 VAC without pre-break AC	9.5	18.5
Fuse protected Power in AC3 (kW)		
Prospective short-circuit current (kA rms)	6	6
Associated fuse rating (A)	32	63
Short-circuit capacity (without protection)		
Rated short-time withstand current I _{cw} 1s (A rms)	640	1000
Connection		
Minimum Cu cable cross-section (mm ²)	2	2
Maximum Cu cable cross-section (mm ²)	16	16
Maximum tightening torque (Nm)	3	3
Mechanical characteristics		
Durability (number of operating cycles)	100 000	100 000
Operating torque (Nm)	1.27	1.27

Characteristics according to UL 60947-4-1 (replaces UL508)

General use rating (A)	30 A	50 A
Short circuit rating at 600 VAC (kA)		5
Branch circuit fuse type		RK5
Max fuse rating (A)		50
Max horsepower rating / Max motor FLA current		
120 VAC / 1 phase	2 / 24	3 / 34
120 VAC / 3 phase	3 / 19.2	5 / 30.4
240 VAC / 1 phase	3 / 17	10 / 50
240 VAC / 3 phase	10 / 28	10 / 28
480 VAC / 3 phase	20 / 27	25 / 34
600 VAC / 3 phase	22 / 27	30 / 32
Connection terminals		
Solid - 1 wire (AWG)		#14 - #6
Solid - 2 wires (AWG)		2 x (#14 - #6)
Auxiliary contacts		
Electrical characteristics		A300
Mechanical characteristics		
Durability (number of operating cycles)		100 000
Operating torque (lbs.in / Nm)		11.24 / 1.27

Dimensions (in/mm)

Back mounting

Direct operation

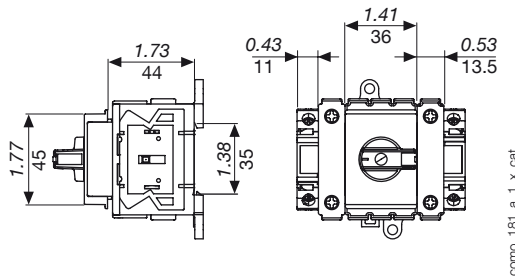

como_181_a_1_x_cat

External operation

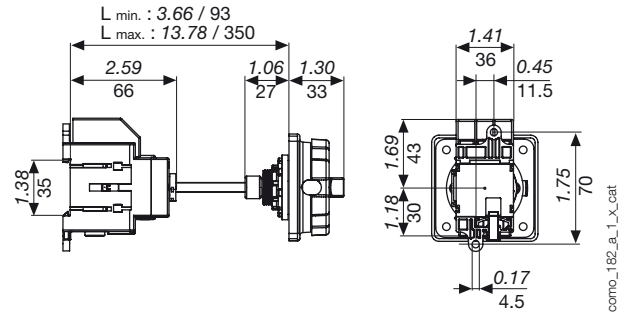

como_182_a_1_x_cat

Door mounting

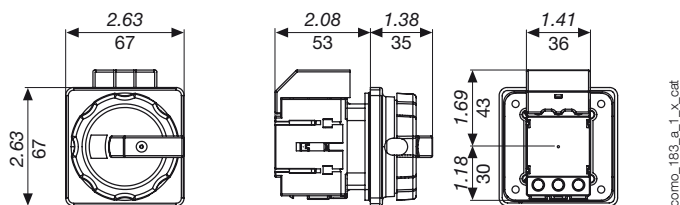

como_183_a_1_x_cat

Door mounting quick fix

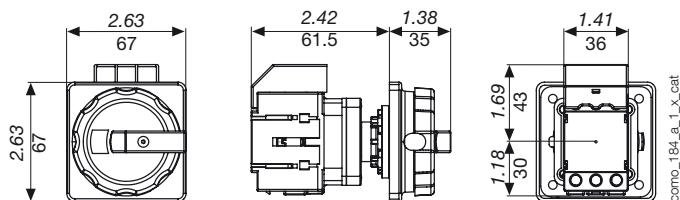

como_184_a_1_x_cat

External handles dimensions (in/mm)

K1 type

Standard handle

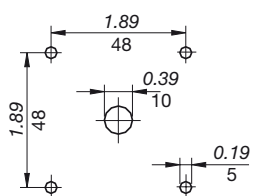

Quick fix handle

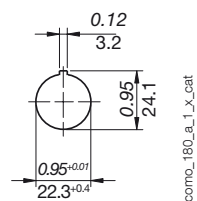

como_180_a_1_x_cat

Socomec: our innovations supporting your energy performance

1 independent manufacturer

3,600 employees
worldwide

10 % of sales revenue
dedicated to R&D

400 experts
dedicated to service provision

Your power management expert



POWER
SWITCHING



POWER
MONITORING



POWER
CONVERSION



ENERGY
STORAGE



EXPERT
SERVICES

The specialist for critical applications

- Control, command of LV facilities
- Safety of persons and assets
- Measurement of electrical parameters
- Energy management
- Energy quality
- Energy availability
- Energy storage
- Prevention and repairs
- Measurement and analysis
- Optimisation
- Consultancy, commissioning and training

A worldwide presence

12 production sites

- France (x3)
- Italy (x2)
- Tunisia
- India
- China (x2)
- USA (x3)

28 subsidiaries and commercial locations

- Algeria • Australia • Belgium • China • Canada
- Dubai (United Arab Emirates) • France • Germany
- India • Indonesia • Italy • Ivory Coast • Netherlands
- Poland • Portugal • Romania • Serbia • Singapore
- Slovenia • South Africa • Spain • Switzerland
- Thailand • Tunisia • Turkey • UK • USA

80 countries

where our brand is distributed

India corporate office

Socomec Innovative Power Solutions Pvt. Ltd.
B1, II Floor
Thiru-Vi-Ka Industrial Estate
Guindy, Chennai - 600 032
Tel: +91 44 3921 5400 / 5466
Mob: +91 9711229993, +91 9940633654
info.in@socomec.com



Manufacturing facility

Socomec India Private Limited.
756 Pace City II
Sector 37
Gurgaon - 122 001
Haryana
Tel: +91 124 4562700, 4597803
Fax: +91 124 4562733
CIN: U00000HR1999PTC038504

Regional & resident offices

Ahmedabad : +91 9987052602, +91 8939008184
Bengaluru : +91 9972578171, +91 9886323448
Chennai : +91 9940147003, +91 9176611256
Cochin : +91 9745012322, +91 8939550688
Coimbatore : +91 9500092236, +91 8939550688
Hyderabad : +91 7338733982, +91 9642528800
Indore : +91 9953595413
Kolkata : +91 9836207671, +91 7550048077
Mumbai : +91 9987947506, +91 8879791802
New Delhi : +91 9958591713, +91 9953595413
Pune : +91 9987052604, +91 8793144968
Trivandrum : +91 9745012322, +91 8939550688
Vadodara : +91 9987052602, +91 8939008184
Vijaywada : +91 9515100473

HEAD OFFICE

SOCOMEK GROUP

SAS SOCOMEK capital 10749940 €
R.C.S. Strasbourg B 548 600 149
B.P. 60010 - 1, rue de Westhouse
F-67235 Benfeld Cedex
Tel. +33 3 88 57 41 41 - Fax +33 3 88 57 78 78
info.scp.isd@socomec.com

YOUR DISTRIBUTOR / PARTNER

www.socomec.co.in

