

CATALOGUE EXTRACT

COMO CS

Manual Cam Transfer Switches
from 25 to 100 A

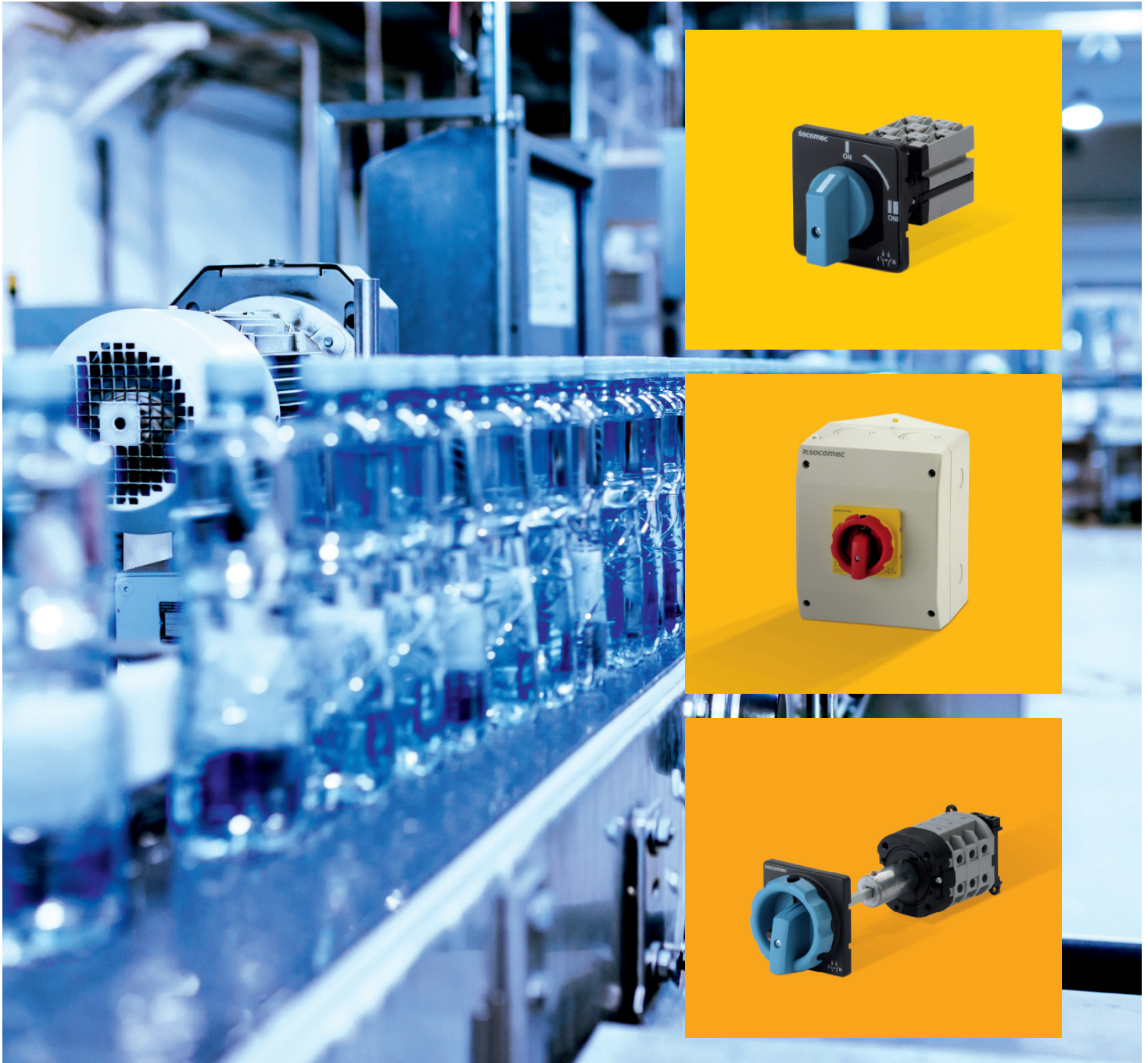

When **energy** matters

 **socomec**
Innovative Power Solutions

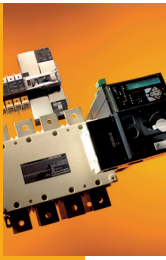

Transfer switches

COMO CS

Manual Cam Transfer Switches

from 25 to 100 A



COMO CS - Door mounting
I-II 3 P 25 A



COMO CS in enclosure
I-0-II 3 P 40 A

Function

COMO CS are manually operated multi-pole transfer switches. They ensure switching, transfer of sources or transfer of two low voltage circuits on load as well as their safe disconnection.

Advantages

Simple installation

The "quick fix" allows significant time saving in fixing the handle to the device. The devices sold in enclosed version are ready for installation.

Quick mounting

The accessories offered are common to all the products in the range. The products are designed for installation:

- on the rear of the cabinet on a backplate,
- on the rear of the cabinet on a DIN rail,
- on the door with a direct handle.

Effective in all circumstances

The devices are available with 3 standard switching types that can cover a wide variety of applications:

- I-II
- I-0-II
- I-0-II with bypass

Please consult us for adaptations to specific wiring diagrams.

The solution for

- > Industry (machine control)



Strong points

- > Simple installation
- > Quick mounting
- > Effective in all circumstances

Compliance with standards

- > IEC 60947-3



- > UL 60947-4-1



* cULus under certification.

Configurations

Backplate switch mounted with external handle

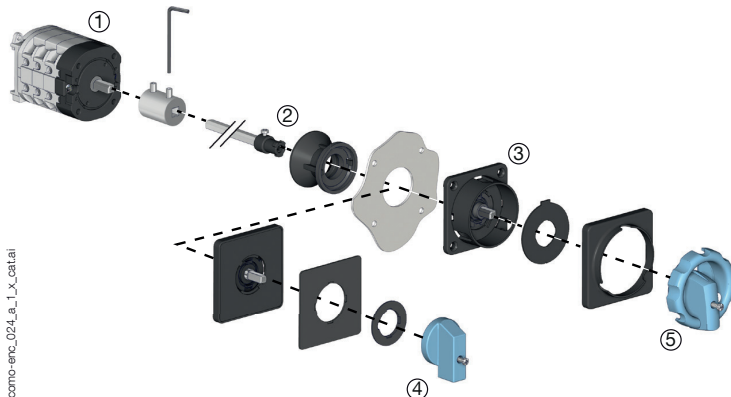

como-enc_024_a_1_x_catal

Functional diagram (for further details see the installation instructions supplied with the product).
1. Shaft extension

- 2. Shaft guide
- 3. Signalling plate
- 4. Non padlockable handle

Direct quickfixing handle for door or backplate mounted switch

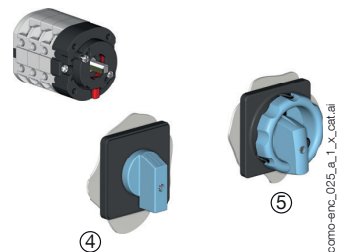

como-enc_025_a_1_x_catal

- 5. Padlockable handle

References

COMO CS

Backplate mounting with direct quickfixing handles or external handles

Rating (A)	N° of poles	Switching type	Switch body rear mounting ⁽¹⁾	Padlockable direct quick fixing handle	Non-padlockable direct quick fixing handle	Padlockable external handle ⁽²⁾	Non-padlockable external handle ⁽²⁾
25 A	3 P	I - II	4320 3002	Blue/Black 4359 3042 Red/Yellow 4359 3043	Blue/Black 4359 3022	Blue/Black 4359 1042 Red/Yellow 4359 1043	Blue/Black 4359 2022
	4 P	I - II	4320 4002				
	3 P	I - 0 - II	4330 3002				
	4 P	I - 0 - II	4330 4002				
	3 P	Bypass I - 0 - II	4350 3002				
40 A	4 P	Bypass I - 0 - II	4350 4002				
	3 P	I - II	4320 3004				
	4 P	I - II	4320 4004				
	3 P	I - 0 - II	4330 3004				
	4 P	I - 0 - II	4330 4004				
63 A	3 P	Bypass I - 0 - II	4350 3004				
	4 P	Bypass I - 0 - II	4350 4004				
	3 P	I - II	4320 3006				
	4 P	I - II	4320 4006				
	3 P	I - 0 - II	4330 3006				
100 A	4 P	I - 0 - II	4330 4006				
	3 P	I - II	4320 3010				
	4 P	I - II	4320 4010				
	3 P	I - 0 - II	4330 3010				
	4 P	I - 0 - II	4330 4010				
	3 P	Bypass I - 0 - II	4350 3010				
	4 P	Bypass I - 0 - II	4350 4010				

(1) Mounting on DIN rail and backplate from 25 to 40 A and mounting on backplate for ratings from 63 to 100 A.

(2) Delivered with shaft and plate for front external control.

Door mounting with direct quickfixing handles

Rating (A)	N° of poles	Switching type	Switch body mounting on door	Padlockable direct quick fixing handle	Non-padlockable direct quick fixing handle
25 A	3 P	I - II	4320 3102	Blue/Black 4359 3042 Red/Yellow 4359 3043	Blue/Black 4359 3022
	4 P	I - II	4320 4102		
	3 P	I - 0 - II	4330 3102		
	4 P	I - 0 - II	4330 4102		
	3 P	Bypass I - 0 - II	4350 3102		
40 A	4 P	Bypass I - 0 - II	4350 4102		
	3 P	I - II	4320 3104		
	4 P	I - II	4320 4104		
	3 P	I - 0 - II	4330 3104		
	4 P	I - 0 - II	4330 4104		
63 A	3 P	Bypass I - 0 - II	4350 3104		
	4 P	Bypass I - 0 - II	4350 4104		
	3 P	I - II	4320 3106		
	4 P	I - II	4320 4106		
	3 P	I - 0 - II	4330 3106		
100 A	4 P	I - 0 - II	4330 4106		
	3 P	I - II	4320 3110		
	4 P	I - II	4320 4110		
	3 P	I - 0 - II	4330 3110		
	4 P	I - 0 - II	4330 4110		
	3 P	Bypass I - 0 - II	4350 3110		
	4 P	Bypass I - 0 - II	4350 4110		

COMO CS

Manual Cam Transfer Switches
from 25 to 100 A

Other solutions with enclosures

General characteristics



como-enc_0119_a.eps

- Available for switching types I-II and I-0-II
- Different enclosure sizes adapted to your needs.
 - Maximum safety during maintenance operations due to triple padlocking of the handle in position 0 (position I for switching type I-II).
 - IP 65 / NEMA 4, 4X : When installed in an industrial environment, protection degree IP 65 and NEMA 4 , 4X ensures that the products are protected against dust and water jets.
 - Red-yellow operating handle.

References

Rating (A)	No. of poles	Switching type	Reference
25 A	3 P	I - II	4321 3C02
	4 P	I - II	4321 4C02
	3 P	I - 0 - II	4331 3C02
	4 P	I - 0 - II	4331 4C02
40 A	3 P	I - II	4321 3C04
	4 P	I - II	4321 4C04
	3 P	I - 0 - II	4331 3C04
	4 P	I - 0 - II	4331 4C04
63 A	3 P	I - II	4321 3C06
	4 P	I - II	4321 4C06
	3 P	I - 0 - II	4331 3C06
	4 P	I - 0 - II	4331 4C06
100 A*	3 P	I - II	4321 3C10
	4 P	I - II	4321 4C10
	3 P	I - 0 - II	4331 3C10
	4 P	I - 0 - II	4331 4C10

* For an ambient temperature of 35 °C

Dimensions (in/mm)

25 to 40 A

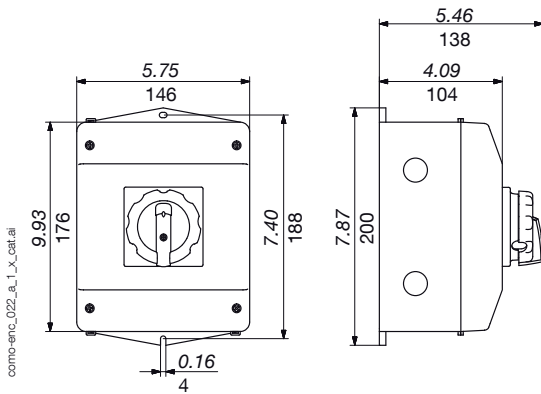

63 to 100 A

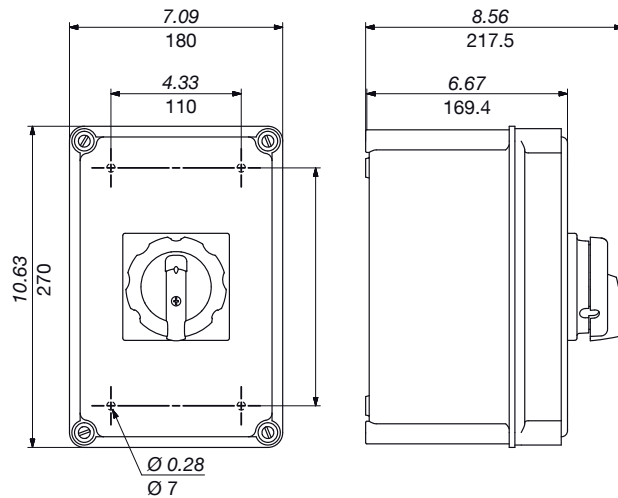

como-enc_003_a_1_X_cat.ai

Characteristics according to IEC 60947-3

25 to 100 A

Conventional free air thermal current I_{th} at 40 °C (A)	25 A	40 A	63 A	100 A
Conventional free air thermal current I_{th} at 50 °C (A)	25	34	63	100
Conventional free air thermal current I_{th} (60 °C) (A)	19	24	53	90
Rated insulation voltage U_i (V)	690	690	690	690
Rated impulse withstand voltage U_{imp} (kV)	4	6	6	6
Rated operational currents I_e (A)				
Utilisation category at 400 VAC				
AC-21A	25	40	63	100
AC-22A	20,5	40	63	100
AC-23A	15	29	63	63
AC-3	12	22		
Utilisation category at 690 VAC				
AC-21A	25	40	/	/
AC-22A	20,5	40	/	/
AC-23A	8,5	17	/	/
AC-3	7	12,8	/	/
Operational power in AC-23 (kW)⁽¹⁾				
At 400 VAC without pre-break AC	7,5	15	37	37
At 690 VAC without pre-break AC	4,8	15	/	/
Fuse protected short-circuit withstand with gG DIN fuses				
Prospective short-circuit (kA rms)	7	10	5	5
Associated fuse rating (A)	25	40	63	100
Rated operational voltage (Va.c)	690	690	415	415
Connection				
Minimum CU cable cross-section (mm ²)	0,5	1	1.5	4
Smaximum CU cable cross-section (mm ²)	4	10	16	35
Tightening torque min - max (Nm)	0.8-1.2	1.2-1.5	2.5	1.5
Mechanical characteristics				
Durability (number of operating cycles)	100 000	100 000	100 000	100 000
Weight of a 3 pole device (g)	109	184	440	440
Weight of a 4 pole device (g)	130	221	535	535

(1) The power is given for information only, the current values vary from one manufacturer to another.

Characteristics according to UL 60947-4-1

25 to 100 A

General use rating (A)	25 A	40 A	63 A	100 A
UL certification file	88EJ		5LM6	
Short circuit rating at 600 VAC (kA)	10	5	/	
Type of fuse	RK5		/	
Max fuse rating (A)	150		/	
Max horsepower rating (HP)				
120 VAC / 1 phase	-	2	/	
120 VAC / 3 phase	-	5	/	
240 VAC / 1 phase	-	3	/	
240 VAC / 3 phase	-	10	/	
480 VAC / 3 phase	-	20	/	
600 VAC / 3 phase	5,2	20	/	
Connection terminals				
Solid wire (AWG)	#14-#12	#14-#8	#14-#4	#10-#2
Wire stripping distance (in/mm)	0.31 / 8	0.39 / 10	0.51 / 13	0.51 / 13
Mechanical characteristics				
Durability (number of operating cycles)	100000	100000	100000	100000
Tightening torque (Lb.in / N.m)	8.8 / 1	13.3 / 1.5	22,1 / 2.5	13.3 / 1.5
Weight of a 3 pole device (lb)	0.24	0.4	1	1
Weight of a 4 pole device (lb)	0.28	0.49	1.18	1.18

COMO CS

Manual Cam Transfer Switches
from 25 to 100 A

Dimensions (in/mm)

25 to 100A

Mounting on door - Fixing with direct handle

Door width		
Unit	Mini	Maxi
in	0.04	1
mm	0.16	4

Rating (A)	Unit	I-II / I-0-II		Bypass I-0-II		C	D
		3 P	4 P	3 P	4 P		
25	in	3.19	3.66	4.13	4.61	1.54	1.57
	mm	81	93	105	117	39	40
40	in	3.31	4.82	4.33	4.84	2.11	2.2
	mm	84	97	110	123	53.6	56
63 - 100	in	4.45	5.28	6.1	6.93	2.91	2.8
	mm	113	134	155	176	74	71

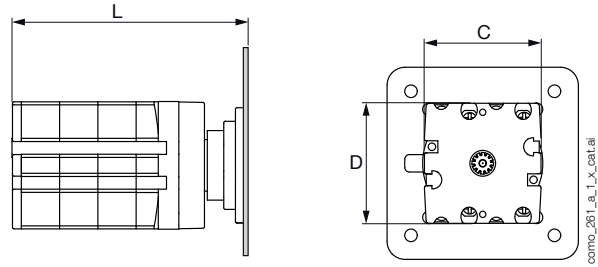

Mounting on backplate / DIN rail - Rear fixing of direct handle

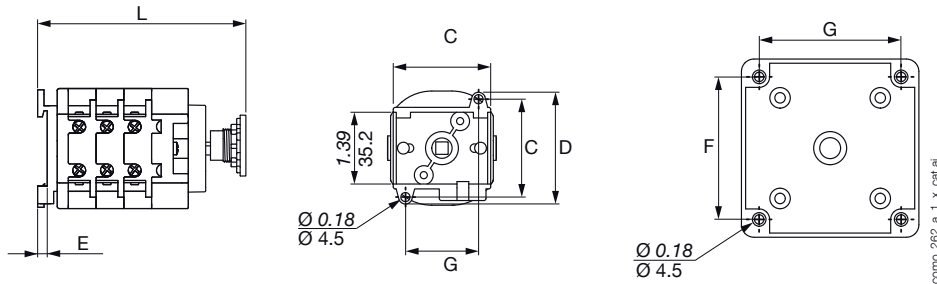

Rating (A)	Unit	I-II / I-0-II		Bypass I-0-II		E	C	D	F	G
		3 P	4 P	3 P	4 P					
25	in	3.20	3.68	4.15	4.57	0.18	1.89	2.2	1.65	1.42
	mm	81.4	93.4	105.4	116.1	4.5	48	56	47	36
40	in	3.73	4.28	4.28	5.08	0.18	1.89	2.2	1.65	1.42
	mm	94.7	107.7	120.7	129	4.5	48	56	47	36
63 ... 100	in	5.10	5.97	6.83	7.54	-	2.99	2.99	2.68	2.68
	mm	129.5	151.5	173.5	191.5	-	76	76	68	68

Mounting on backplate / DIN rail - Rear fixing of external handle

Rating (A)	Unit	X-L ⁽³⁾		C		D	
		I-II / I-0-II	Bypass I-0-II	3 P	4 P		
25	in	3.19	3.66	4.13	4.61	1.54	1.57
	mm	81	93	105	117	39	40
40	in	3.31	4.82	4.33	4.84	2.11	2.2
	mm	84	97	110	123	53.6	56
63...100	in	4.45	5.28	6.1	6.93	2.91	2.8
	mm	113	134	155	176	74	71

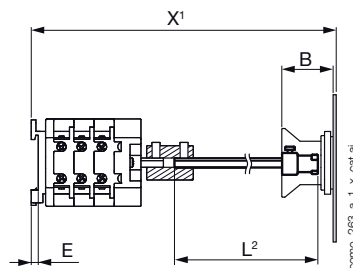

- (1) X is the distance between the inside of the door and the fixing plate
 (2) L is the total length of the shaft (max 200 mm)
 (3) Minimum distance between the inside of the door and the fixing plate

Dimensions for handles

25 to 100 A

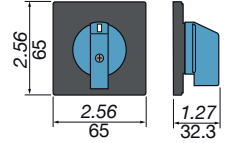
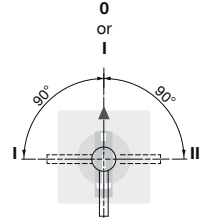
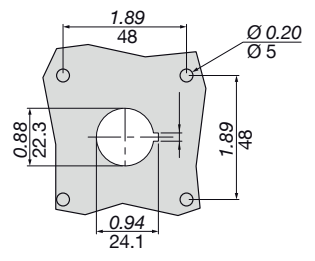
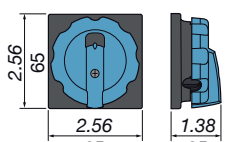
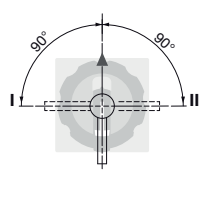
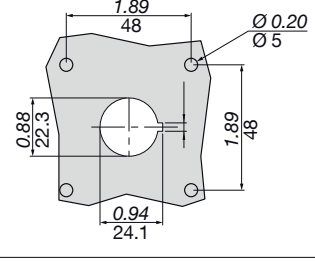
Handle type	Front operation Direction of operation	Door drilling
<p>K1 type non padlockable</p> 	<p>0 or I</p> 	 <p style="text-align: right; font-size: small;">paign_075_a_1_gb_catal</p>
<p>K1 type padlockable</p> 	<p>0 or I</p> 	 <p style="text-align: right; font-size: small;">paign_076_a_1_gb_catal</p>

Socomec: our innovations supporting your energy performance

1 independent manufacturer **3,600** employees worldwide **10** % of sales revenue dedicated to R&D **400** experts dedicated to service provision

Your power management expert



POWER SWITCHING



POWER MONITORING



POWER CONVERSION



ENERGY STORAGE



EXPERT SERVICES

The specialist for critical applications

- Control, command of LV facilities
- Safety of persons and assets
- Measurement of electrical parameters
- Energy management
- Energy quality
- Energy availability
- Energy storage
- Prevention and repairs
- Measurement and analysis
- Optimisation
- Consultancy, commissioning and training

A worldwide presence

12 production sites

- France (x3)
- Italy (x2)
- Tunisia
- India
- China (x2)
- USA (x3)

28 subsidiaries and commercial locations

- Algeria • Australia • Belgium • China • Canada
- Dubai (United Arab Emirates) • France • Germany
- India • Indonesia • Italy • Ivory Coast • Netherlands
- Poland • Portugal • Romania • Serbia • Singapore
- Slovenia • South Africa • Spain • Switzerland
- Thailand • Tunisia • Turkey • UK • USA

80 countries

where our brand is distributed

HEAD OFFICE

SOCOMEK GROUP

SAS SOCOMEK capital 10 589 500 €
R.C.S. Strasbourg B 548 500 149
B.P. 60010 - 1, rue de Westhouse
F-67235 Benfeld Cedex
Tel. +33 3 88 57 41 41 - Fax +33 3 88 57 78 78
info.scp.isd@socomec.com

YOUR DISTRIBUTOR / PARTNER

www.socomec.com

