

DIRIS Digiware R-60

Residual Current Monitoring module

new



diris-dw_173_front

DIRIS Digiware R-60



Configuration with
Easy Config System software.

Function

DIRIS Digiware R-60 modules combine residual current monitoring (RCM) with power metering and monitoring functions, for any combination of 1-phase, 2-phase or 3-phase circuits used in TN-S and TT earthing systems.

With six RJ12 channels, they can be connected to a mix of Δ IC residual CTs and TE/TR/ITR/TF current sensors via RJ12 cables enabling quick connection and avoiding wiring errors.

Advantages

2 in 1

One DIRIS Digiware R-60 module can be connected to residual CTs and traditional TE/TR/ITR/TF current sensors to pool residual current and power monitoring.

Multi-circuit

One DIRIS Digiware R-60 module can monitor the residual current on up to 6 circuits.

The Digiware modular concept allows several R-60 modules to be added within a single system, making it easy to implement RCM for a large number of outgoing circuits instead of the main incomer only.

Plug & Play solution

The Digiware concept and the RJ45 bus allow:

- easy connection of R-60 modules to an existing DIRIS Digiware system,
- optimal scalability by adding additional modules when needed.

The connection to current sensors is quick and error-free thanks to colour coded RJ12 cables.

Smart alarming

DIRIS Digiware R-60 provides the most advanced RCM alarm features for preventive notifications:

- before the residual current device (RCD) trips,
- before leakage currents become hazardous for people and assets,
- if the RCD is defective.

The combination with Virtual Monitor technology specifies if the RCD has tripped on an overload or a high residual current.

Patented innovation

Thanks to an automatic learning sequence, launched for a chosen duration representative of the normal operation of the electrical installation, 6 dynamic residual current (I_{Δ}) thresholds are automatically set. This facilitates the determination of the maximum residual current not to be exceeded for each outgoing circuit.

The solution for

- > Industries
- > Data centres



Strong points

- > 2 in 1
- > Multi-circuit
- > Plug & play solution
- > Smart alarming
- > Patented innovation

Compliance with standards

- > IEC 62020
- > IEC 61557-12



- > ISO 14025



Create your project

- > Find the best DIRIS Digiware configuration:
www.meter-selector.com

METER SELECTOR
DIGITAL TOOL AVAILABLE

Applications

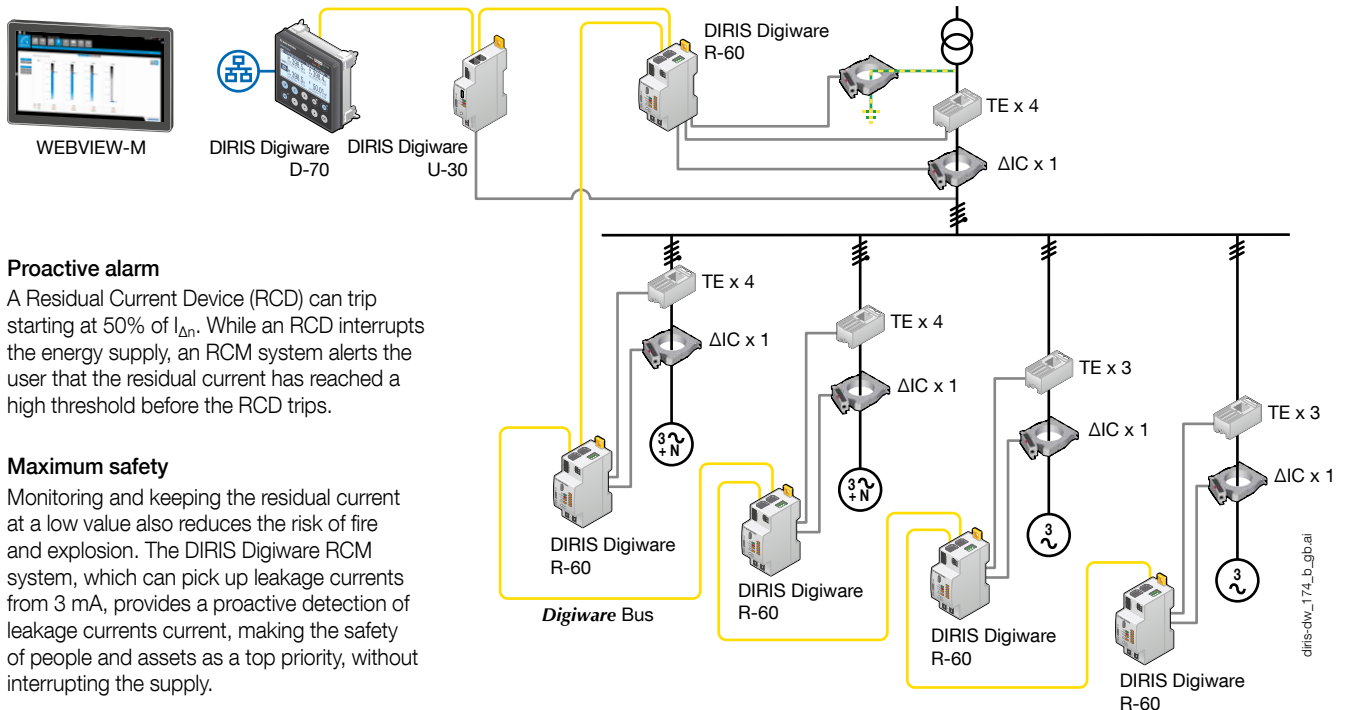

Proactive alarm

A Residual Current Device (RCD) can trip starting at 50% of $I_{\Delta n}$. While an RCD interrupts the energy supply, an RCM system alerts the user that the residual current has reached a high threshold before the RCD trips.

Maximum safety

Monitoring and keeping the residual current at a low value also reduces the risk of fire and explosion. The DIRIS Digiware RCM system, which can pick up leakage currents from 3 mA, provides a proactive detection of leakage currents current, making the safety of people and assets as a top priority, without interrupting the supply.

Protective earthing (PE) conductor

Adding a residual CT on the upstream PE conductor is essential to ensure the proper connection to earth. It is also the easiest and cheapest way to measure the upstream residual current reliably.

Compliance with installation standards

Many local electrical codes require an insulation resistance measurement as part of the Periodic Inspection and Testing. This operation is costly as it must be done on all outgoing circuits and intrusive as the main protective device must be opened.

According to IEC 60364-6 installation standards and many national transpositions, periodic insulation resistance testing is not necessary if permanently monitored by an RCM solution such as the DIRIS Digiware RCM system.

Measurements

	
DIRIS Digiware R-60	
Residual Current Monitoring	
I_{Δ}	•
I_{PE}	•
Metering	
+/- kWh, +/- kvarh, kVAh	•
Multi-tariff (max 8)	•
Load curves	•
Multi-measurement	
$I_1, I_2, I_3, I_n, \Sigma P, \Sigma Q, \Sigma S, \Sigma PF$	•
P, Q, S, PF per phase	•
Alarms	
Dynamic I_{Δ} and I_{PE} thresholds	•
Overloaded neutral conductor	•
Protective device (opening, Trip, defective RCD)	•
I_{Δ} and I_{PE} comparisons	•
Trends	
I_{Δ}	•
I_{PE}	•
Load curves	•

Front face

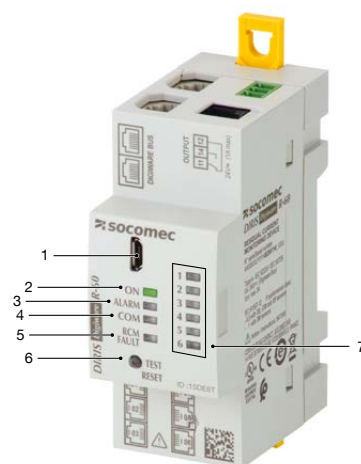

1. USB port for configuration.
2. ON LED. Lights when the device is active.
3. ALARM LED for system alarms (CT disconnected, etc.)
4. COM LED. Flashes when the communication bus is active.
5. RCM FAULT. Lights if there is an RCM alarm on any of the channel 1 through 6.
6. TEST / RESET button. Starts the auto test (long press) and resets alarms (short press). Used during auto-discovery process for the resolution of address conflicts.
7. Individual LED alarm signals for each channel 1 to 6.

DIRIS Digiware R-60

Residual Current Monitoring module

Connections

Associated sensors

Various types of residual CTs and current sensors can be connected to the DIRIS Digiware R-60 module: Δ IC solid-core, Δ IP-R split-core residual CTs, and solid-core TE, split-core TR/iTR, flexible TF current sensors. This range of sensors can be adapted to all types of new or existing installations. A rapid RJ12 connection makes wiring easy and reliable and prevents wiring errors.

For more information: refer to the residual CTs and current sensors catalogue pages

TE solid current sensors



Δ IC solid-core residual CTs



TR/iTR split-core current sensors



TF Flexible current sensors



Δ IP-R split-core residual CTs

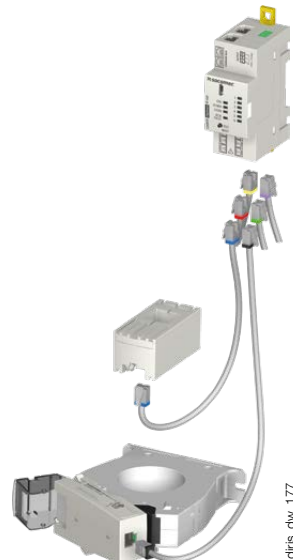

Connection examples

RCM (I_{Δ}) – 3 x 3-Ph load

Load current monitoring – L1, L2, L3, upstream

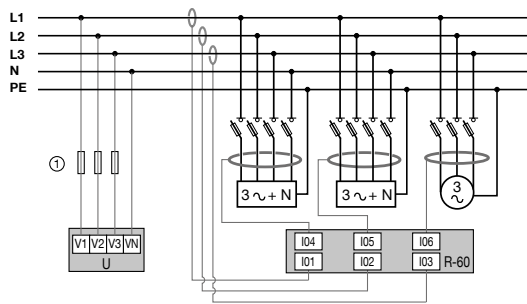

diris-dw_176_b_1_x_catal

RCM ($I_{\Delta} + I_{PE}$) – 1 x 3-Ph load

Load current monitoring – 1 x 3-Ph load (L1, L2, L3, N)

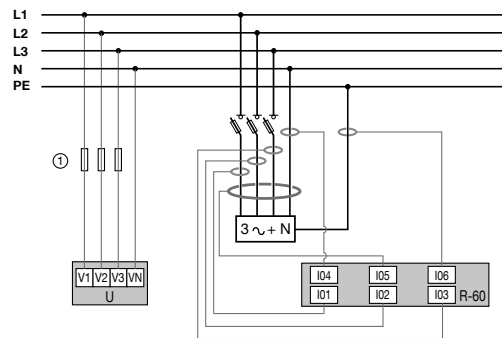

diris-dw_179_a_1_x_catal

RCM (I_{Δ}) – 3 x 3-Ph load

Load current monitoring – 3 x 3-Ph balanced loads

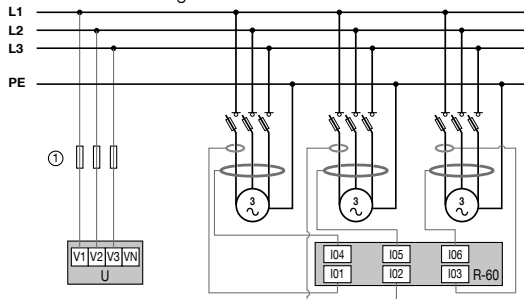

diris-dw_180_a_1_x_catal

RCM (I_{Δ}) – 3 x 1-Ph load

Load current monitoring – 3 x 1-Ph loads

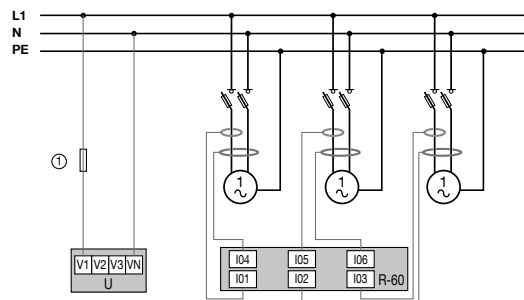

diris-dw_181_a_1_x_catal



Dimensions (mm)

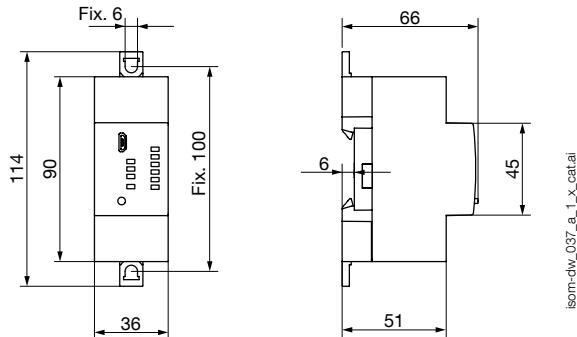

Terminals and wiring

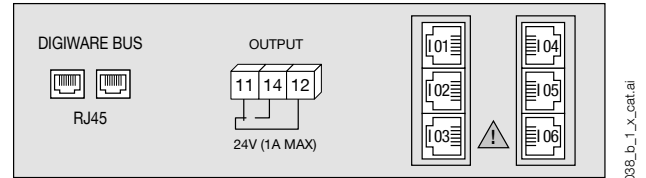

DIGIWARE BUS: RJ45 bus to connect to other Digiware modules

11 - 12 - 14: alarm relay output
I01 - I02 - I03 - I04 - I05 - I06: RJ12 connection of residual CTs (via the T-10 adaptor) and current sensors

Technical characteristics

Measurement characteristics

RCM type	Type A according to IEC 62020
Number of RJ12 channels	6
Residual CTs connection	RJ12 cables via Digiware T-10 adaptor
Current sensors connection	RJ12 cables
Current measurement accuracy	Class 0.5 according to IEC 61557-12
Active energy accuracy	Class 0.5 according to IEC 61557-12
Reactive energy accuracy	Class 1 according to IEC 61557-12

Digital output characteristics

Number of contacts	1
Contact type	Changeover switch
Nominal voltage	24 VAC / 24 VDC
Max current	1 A
Default mode	Normally open

Mechanical characteristics

Mounting type	DIN rail or back plate
Casing protection index	IP20
Weight	103 g

Electrical characteristics

Auxiliary power supply	24 VDC with Digiware bus
R-60 consumption	0.5 W

Communication characteristics

Digiware bus	
Function	Connection between Digiware modules
Cable type	Specific Socomec RJ45 cable
USB	
Protocol	Modbus RTU on USB
Function	Configuration of DIRIS Digiware modules
Cable type	Type B micro USB connector

Environmental characteristics

Operating temperature	-10 ... +55°C
Storage temperature	-25 ... +70°C
Operating humidity	55°C / 97% RH
Operating altitude	< 2000 m

References

Module	Reference
DIRIS Digiware R-60	4829 0114
Accessories	Reference
DIRIS Digiware T-10 RJ12 adaptor	4829 0620

RJ12 connection cables	Cable length (m)									
	0.1	0.2	0.3	0.5	1	2	3	5	10	50 m reel + 100 connectors
Number of cables	Reference	Reference	Reference	Reference	Reference	Reference	Reference	Reference	Reference	Reference
1	-	-	-	-	-	-	-	4829 0602	4829 0603	4829 0601
3	4829 0580	4829 0581	4829 0582	4829 0595	4829 0583	4829 0584	4829 0606	-	-	-
4	-	-	-	4829 0596	4829 0588	4829 0589	-	-	-	-
6	4829 0590	4829 0591	4829 0592	4829 0597	4829 0593	4829 0594	-	-	-	-

Expert Services

Require integration onto your network?

No problem for our "Expert Services" team. They will fully integrate all your SOCOMEC devices, **audit** your system, **commission** selected equipment and **train** your staff on its use.

For further information, please contact your nearest SOCOMEC branch.